

"SYM JUMBO"

*Design registration pending

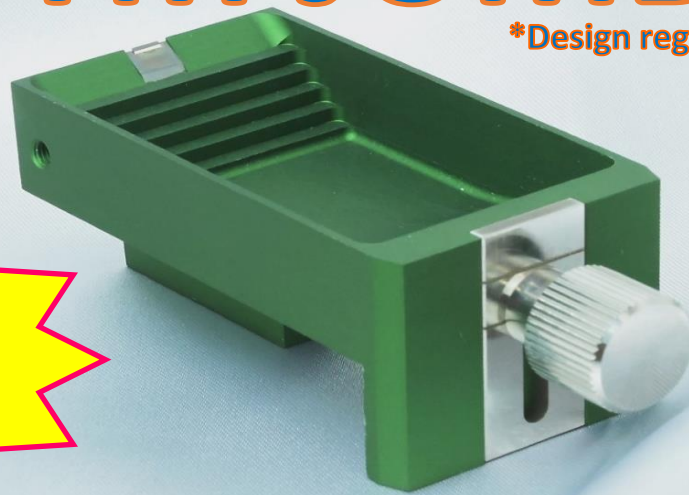

"New"
product
from Japan

See things from a different perspective

Striking innovation ①



No slope, "Steps"

Striking innovation ②

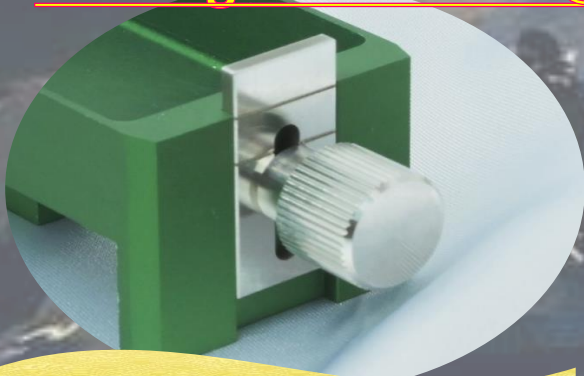

"Adjustable" height

Striking innovation ③

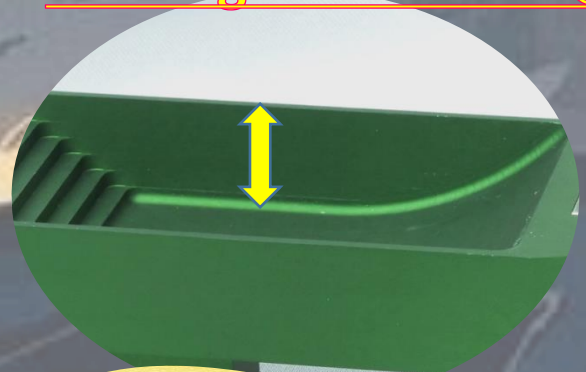

"Deeper" boat

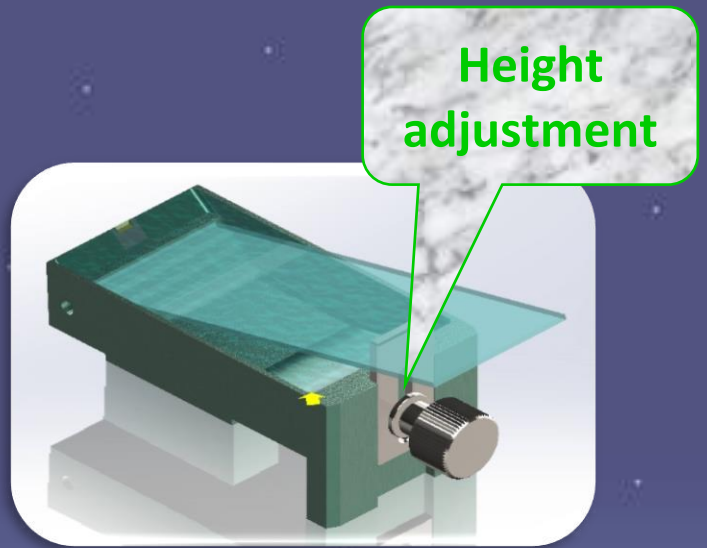
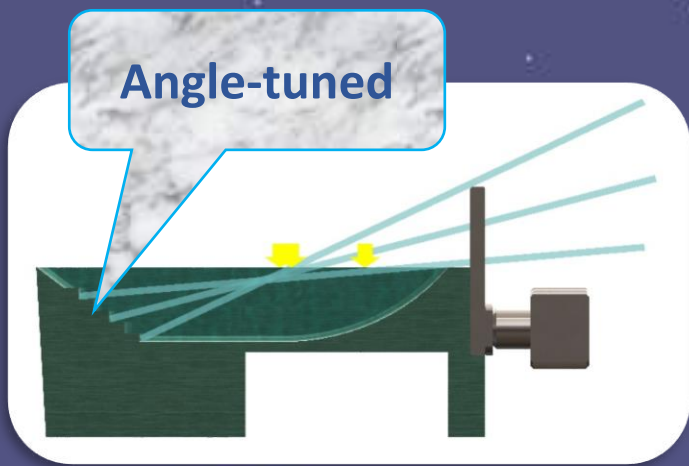

You can set the edge of water as desired.
It brings you to use it much easier than now.
Safeguard against water leak.

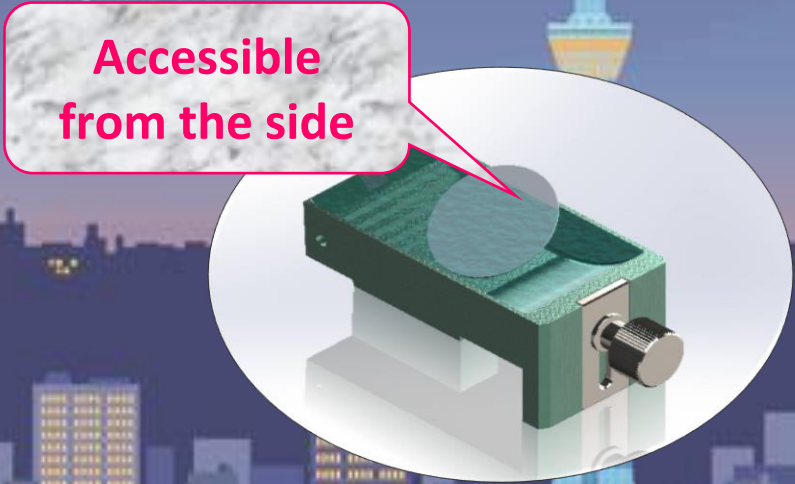
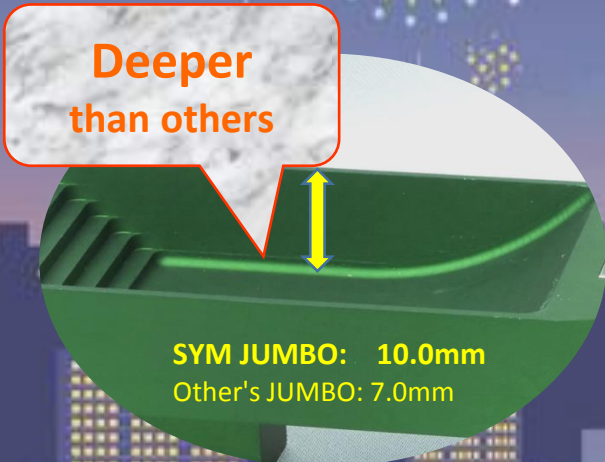

Deeper than other maker's JUMBO.
Collect sections easily.

Description	Angle	Width(mm)	Model No.	New	Exchange
Ultra (Wet) Recommended range 200nm to 30 nm	35°	2.0 (2.0 to 2.2)	SYM2035J	OK	*OK
		2.0 (2.0 to 2.2)	SYM2045J	OK	*OK
	45°	2.5 (2.5 to 2.7)	SYM2545J	OK	*OK
		3.0 (3.0 to 3.2)	SYM3045J	OK	*OK
Histo (Wet) Recommended range 2µm to 0.2µnm	50°	3.0 (3.0 to 3.2)	SYM3050HJ	OK	*OK

*Exchange is done on blade part only. Body will be used again.



All knives are made in Japan
SYNTEK CO., LTD.
Tel: +81(0)45-500-6603
Email: info@syntek.co.jp
Website: www.syntek.co.jp/en

